



MECHRON

22 HP



MECHRON

Go anywhere, and have fun doing it.

With 4WD, adjustable rear wishbone suspension, the widest cargo bed in its class, plus models with one or two rows of seating to choose from, if you have land, you should have one of these bad boys.

Power Steering Models

54" Wide Cargo Bed

12" Ground Clearance

1 & 2 Row Models

Heavy Duty Work Horse

Field Option Cab Available

KIOTI

KIOTI
4x4



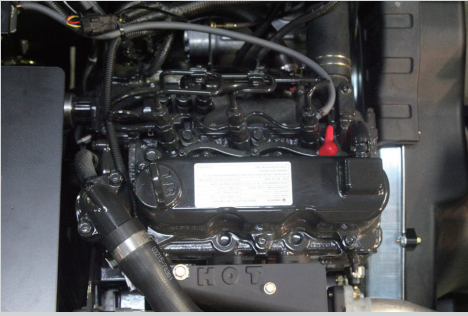

Engine

The Daedong 3C100LFU(1,007cc, 22hp) diesel engine has been field proven for durability and dependability while offering improved fuel economy.

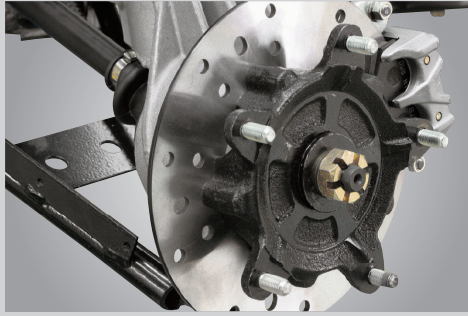

Brake System

Long lasting front and rear hydraulic disc brakes with amechanical parking brake provides excellent performance and enhanced safety.

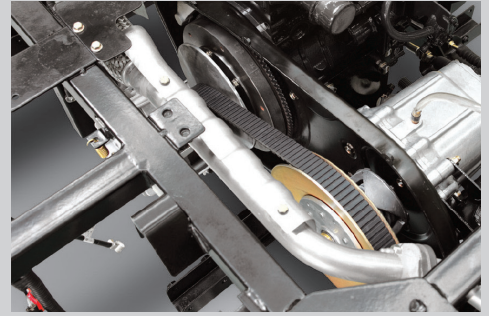

Transmission

The MECHRON uses a continuously variable transmission(CVT) and has a time proven Daedong gear box with two speeds, (Hi/Lo) and 4WD.

Power Train Lay Out

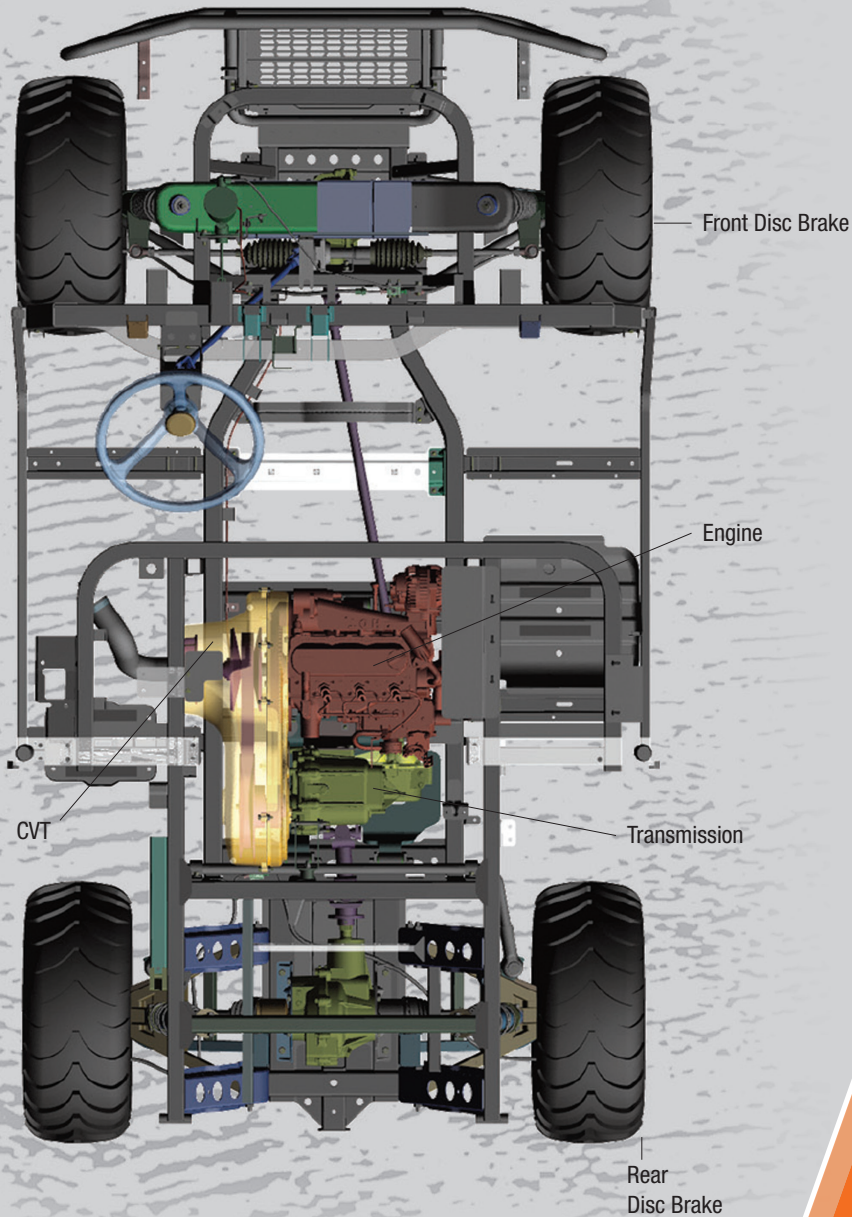

POWERFUL ACCELERATION WITH A DAEDONG DIESEL ENGINE

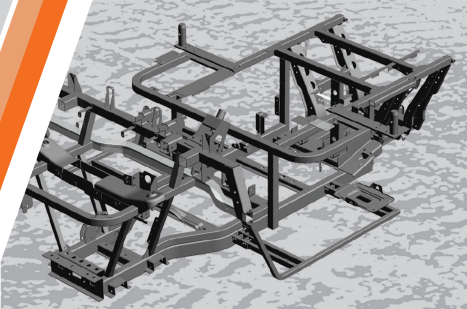

Solid Frame

Robust body frame with strong tubular steel and welded ROPS will protect drivers and passengers.

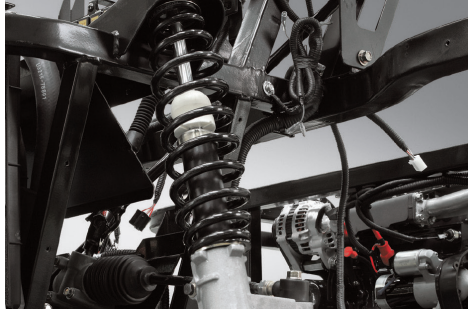

Front Suspension

A MacPherson Strut type suspension ensures the best ride of all the competition while providing the driver excellent road-feel and control.

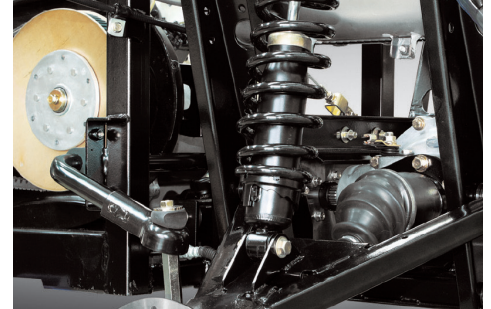

Adjustable Rear Suspension

With an adjustable Wishbone type suspension, you can fine tune the MECHRON for the smoothest possible ride whether carrying a load or empty.

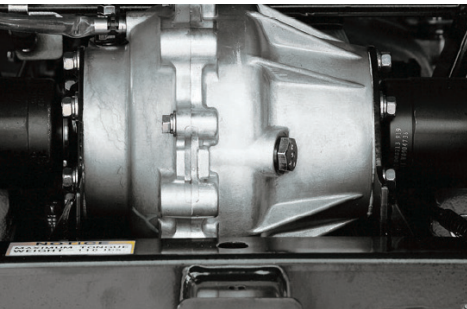

Rear Hitch Receiver

A 2-inch rectangular hitch receiver enables you to attach a trailer and receiver equipped implements.



Tire Options

With four tire options, owners can customize the MECHRON to fit their needs. Aluminum wheels are available on Heavy Duty, ATV and Tomahawk tires.



Wheels

Larger 12-inch wheels and 25-inch tires provide a smooth ride and more ground clearance.



Differential Locks

- Front : Limited Slip Differential
- Rear: Mechanically Actuated Differential Lock

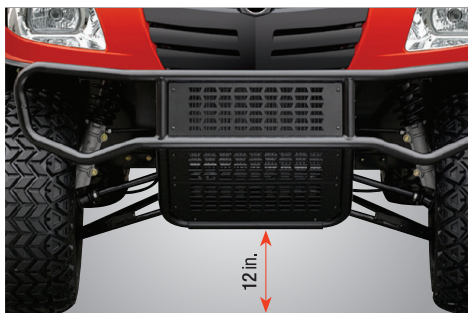

Ground Clearance

Don't get stuck on the trail. With 12 inches of ground clearance, you can easily climb over obstacles.



Rear Fenders

Reinforced, molded rear fenders mounted under the bed deck keep you and your MECHRON clean under the muddiest conditions.



FIELD OPTION CAB

(Option on 2200/2200PS)

The KIOTI Field Option Cab provides an opening windshield, sliding rear and door glass, dome lamp, wipers with washer fluid switch and an optional heater.



Floor

With a flat walk-thru design, the MECHRON has excellent leg and foot room for easy entry and exit.

2-Row seating of the MECHRON 2240 provides a comfortable environment for 4 people.



Dash Board

With its cockpit-like looks, the ergonomically located controls and instruments allow the driver to view critical functions at a glance.



Shift Levers

An in-line shift makes range selection simple and easy. 4WD selection and rear differential lock are engaged with a single pull knob.



Canopy (Option)

An impact resistant plastic canopy helps to protect the driver and passengers.



Hood

The sleek design of the reinforced plastic hood provides a strong and dynamic look.



Brush Guard

The heavy duty steel brush guard offers protection for the headlights and radiator from rocks, tough brush, and other debris on the trail.



Cargo Bed

The MECHRON provides excellent payload capabilities and has the widest cargo bed in its class. Add the optional hydraulic dump kit and you can easily place any load where you want it.



Bench Seat

With a contoured bench seat that is the widest in its class, the 2200 offers room to seat three comfortably. Seat belts are standard for safety.

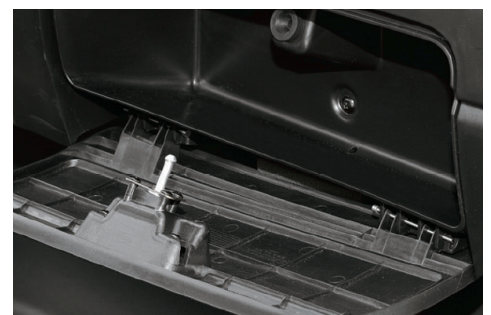

Storage Compartments

An open dash storage area on the driver side is complemented by a closed dash storage area with a water proof lid on the passenger side.

SPECIFICATIONS



MODEL	MECHRON2200	MECHRON2200PS	MECHRON2240
ENGINE			
Model	3C100LFU-4		
Type	3Cyl., In-line Vertical, Water-cooled 4-cycle diesel engine		
Engine Gross	hp (kW)	22 (16.4)	
Displacement	cu. in. (cc)	61.45 (1,007)	
Rated Revolution	rpm	2,800	
Fuel Tank Capacity	US gal. (l)	7.4 (28)	
DRIVE TRAIN			
Type	Type Belt CVT		
Gear Range	Low, High, Neutral, Reverse		
Ground Speed	mph (km/h)	0-25 (0-40)	
Brake	Front/Rear Hydraulic Dry Caliper Disc		
SUSPENSION			
Front Suspension	Independent, MacPherson Strut type		
Rear Suspension	Independent, Double A-Arm (Wishbone type)		
STEERING			
Type	Rack & Pinion	Hydraulic Power	
DIMENSIONS / CAPACITY			
Length	in. (mm)	112.3 (2,852)	146.7 (3,725)
Width	in. (mm)	60.7 (1,543)	
Height	in. (mm)	76.4 (1,940)	
Max.Wheel Tread	Front	49.7 (1,262)	
	Rear	48.3 (1,228)	49.8 (1,264)
Wheelbase	in. (mm)	76.4 (1,940)	108.7 (2,760)
Weight (with ATV Tires)	lbs. (kg)	1,861 (844.1)	2,252 (1,021.5)
Ground Clearance	in. (mm)	12 (304)	
Towing Capacity	lbs. (kg)	1,300 (590)	
Payload Capacity	lbs. (kg)	1,598 (725)	
Turning Radius	ft. (m)	13.1 (4)	17.7 (5.4)
Seat Capacity / Style		3 / Bench	2 Per Bench / 2 Bench Seats
CARGO BED			
Length x Width x Depth	in. (mm)	38.6 (980)×56.2 (1,427)×11.5 (293)	
Bed Capacity	lbs.(kg)	1,102 (500)	662 (300)
Dump Box Actuation		Manual	
TIRE SIZE			
Front	Heavy Duty Worksite	25×10-12	
	Turf	26×9.5-12	
	ATV	25×10-12	
	Tomahawk	25×10-12	
Rear	Heavy Duty Worksite	25×10-12	
	Turf	26×9.5-12	
	ATV	25×11-12	
	Tomahawk	25×10-12	
BODY			
Body Color		Red / Green	
STANDARD EQUIPMENT			
Front Guard		Standard	
Speedometer		Standard	
Rear Hitch Receiver		Standard	
Safety Lamp Kit (Brake Lights, Turn Signal Lamps, Hazard Switch)		Standard	
Winch Bracket	Optional	Standard	Optional

OPTIONAL EQUIPMENT

- Sun Canopy Kit
- Windshield Kit
- Windshield Wiper Kit
- Hydraulic Dumping Kit
- Remote Hydraulic Kit
- Hand Throttle Kit
- Skid Plate Kit
- Rear Screen Kit
- Suspension Dust Guard Kit
- CV Guard Kit
- Muffler Spark Arrester Kit
- Horn
- Fog Lamp Kit
- Working Lamp Kit
- Headrest Kit
- Side View Mirror Kit
- Side Rail Extension Kit
- License Plate Kit
- Parking Brake Buzzer Kit
- Winch Kit
- Field Option Cab (MECHRON 2200 only)
- Soft Cabin Kit (MECHRON 2200 only)
- Front Hitch Receiver Kit

* NOTE : Specifications and design are subject to change without notice.



KIOTI Tractor Division
 DAEDONG - USA, INC.
 6300 KIOTI Drive, Wendell, NC 27591 USA
 Toll free 877-GO-KIOTI • Fax 919-374-5001
 Web www.KIOTI.com

